

SAHA
YAYIN



12. Uluslararası Madencilik, Tünel İnşaa,
Makine Ekipmanları ve İş Makineleri Fuar

KATALOĞU



2026

SAH SOYLU ATLAS
HİDROLİK

HİDROLİKTE SAĞLAM ÇÖZÜM

KUSURSUZ MONTAJ



+90 553 338 17 40

www.soyluatlashidrolik.com

İvedik OSB Arı Sanayi Sitesi 1468.Cadde No:104 Yenimahalle/ANKARA



BABACAN[®] RUBBER

ALWAYS FOR THE BETTER



40 Yıllık Deneyim, Güvenilir Çözümler.

1986 yılında çıktığımız bu yolda, Babacan Kauçuk olarak Türkiye'nin kauçuk ve poliüretan yedek parça üretiminde güvenilir ve öncü firmalarından biri haline geldik. Bugün biri endüstriyel kauçuk üretimine, diğeri ise savunma sanayi ve özel projelere odaklanan iki ayrı üretim tesisimizde geliştirdiğimiz yenilikçi çözümlerle yalnızca Türkiye'de değil, dünyanın birçok ülkesinde çözüm ortağı olarak faaliyet gösteriyoruz.

İş makineleri, raylı sistemler, maden ve delici makineleri, savunma sanayi, tarım makineleri, enerji ve hidrolik sistemleri için kauçuk ve poliüretan yedek parçalar üretiyoruz. Titreşim takozları, süspansiyon elemanları, kaplinler, burçlar, sızdırmazlık ürünleri ve özel mühendislik parçaları gibi birçok ürünü yüksek kalite standartlarında üreterek müşterilerimizin ihtiyaçlarına özel çözümler sunuyoruz.

- Telefon :** +90 544 746 99 53 - 444 4 970
Website : www.babacankaucuk.com
Mağaza : 100. Yıl Bulvarı No:44 Ostim-Ankara/TÜRKİYE
Fabrika 1: Fevzi Çakmak Mah. 37.Cad. No: 7 06946 Yenikent Ankara/TÜRKİYE
Fabrika 2: SARAYOSB Mah, 41 Sokak No:18 06980 Ankara/TÜRKİYE



İş Makinaları YEDEK PARÇALARI

- Titreşim Takozları
- Kaplinler
- Sızdırmazlık Ürünleri
- Motor & Kabin Takozları
- Makas Takozları
- Poliüretan Sıyırıcılar

Raylı Sistemler YEDEK PARÇALARI

- Şevron takozları
- Birincil ve ikincil süspansiyon takozları
- Kauçuk profiller
- Burçlar
- Körükler
- Titreşim takozları



Delici ve Maden YEDEK PARÇALARI

- Kırıcı yedek parçaları
- Delici yedek parçalar
- Konkasör yedek parçaları
- Elek takozları
- Poliüretan elekler

www.babacankaucuk.com

ERBAŞI

VİNÇ MAK. SAV. SAN. VE TİC. LTD. ŞTİ.



ÇİFT KİRİŞ VİNÇ SİSTEMİ
TEK KİRİŞ VİNÇ SİSTEMİ
PEGEL VİNÇ SİSTEMİ
VİNÇ KALDIRMA GRUBU
TRANSFER ARABASI
PORTAL VİNÇ SİSTEMİ
TEKNİK SERVİS VE BAKIM



ERBAŞI VİNÇ MAK. SAV. SAN. VE TİC. LTD. ŞTİ. 2002 yılından bu yana kaldırma ve ileme sistemleri alanında kalite standartlarını sürekli yükselterek faaliyet göstermektedir. Kahramankazan, Ankara'da, Saray Mahallesi'nde bulunan Saraykent Sanayi Sitesi'ndeki iki fabrikamızda toplamda 2000 m² alanda (1500 m² kapalı, 500 m² açık), alanında uzman 20 kişilik bir ekip ile çalışmalarımızı sürdürmekteyiz.

Yüksek mühendislik ve malzeme kalitesine odaklanan ERBAŞI VİNÇ, müşteri memnuniyetini öncelik olarak ekonomik fiyatlarla üstün hizmet sunmayı hedeflemektedir. Gelişmiş metal imalat kabiliyetlerimiz sayesinde savunma sanayi için özel üretimler de gerçekleştirmektediriz.

FAALİYET ALANLARIMIZ:

Firmamız; kaldırma-ileme ekipmanları, vinç-taşıyıcı sistemler ve aksesuarlarının yanı sıra: Seri üretim, Sipariş özel üretim, Satış ve

pazarlama, Satış sonrası hizmetler, Saha montajı, Periyodik bakım ve Revizyon hizmetleri alanlarında 20 yılı aşkın deneyimle hizmet vermektedir.

ÜRÜN GRUPLARIMIZ:

ERBAŞI VİNÇ, dünya standartlarında üretim yapabilme kabiliyetiyle şu ürünleri sunmaktadır:

- ZİNCİRLİ VE HALATLI CERASKALAR
- HALATLI VİNÇLER
- TEK KİRİŞLİ GEZER KÖPRÜLÜ VİNÇLER
- ÇİFT KİRİŞLİ GEZER KÖPRÜLÜ VİNÇLER
- PERGEL VİNÇLER
- ÖZEL İMALAT TAŞIMA APARATLARI
- MONORAY VİNÇLER
- PORTAL VİNÇLER VE ÖZEL İMALAT PROSES VİNÇLER

Saray Mahallesi 55. Cadde No:21
Kahramankazan / ANKARA
erbasivinc.com.tr erbasivinc.com
info@erbasivinc.com.tr
erbasivincsanayi@outlook.com



0312 271 92 61
0541 870 07 99
0535 870 07 99

HAKKIMIZDA

Firmamız kuruluşundan bugüne dürüst, titiz çalışma ve kaliteli üretim ilkesinden ayrılmayan firmamız giderek artan rekabet koşullarını da göz önüne alarak mümkün olan en uygun fiyatlarla hizmet verebilmek için gereken önemi göstermektedir.



HİDROLİK HORTUM MONTAJI | ATLAS, SANDVIK VE TAMROCK

BAKIM VE SERVİS HİZMETLERİ | TEKNİK DESTEK VE YERİNDE MÜDAHALE



www.soyluatlashidrolik.com

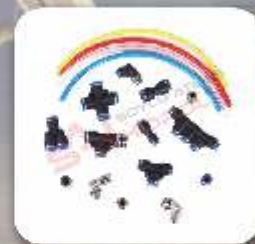

2026



MADEN

TÜRKİYE

12. Uluslararası Madencilik, Tünel İnşa, Makine Ekipmanları ve İş Makineleri Fuar
KATALOĞU

İÇİNDEKİLER

Kapak	SOYLU ATLAS HİDROLİK	19	AZE HİDROLİK
Ön Kapak İçi	BABACAN KAÇUK	20	BETON MARKET
Arka Kapak İçi	TEZULAS TOS+H 2026	21	ER-KA GRUP
Arka Kapak	HAKİM HİDROLİK	22	FLOW HİDROLİK
		23	GENMAK
		24-25	HAKİM HİDROLİK
1	ERBAŞI VİNÇ	26	HİDROEKOL HİDROLİK
2-3	SOYLU ATLAS HİDROLİK	27	HİDROMİL
5	AYDINONAT	28	HİDRO-SİSTEM HİDROLİK
6	BRONZ METAL	29	HİDROTEK TEKNİK
7	HANSA FLEX	30	MANAS SONDAJ
8-9	HASIRCI HİDROLİK	31	ORGLOBAL MAKİNA ROCK DRILL
10	EGE ATLAS	32	ÖZTEKNİK REKOR
11	RPM SONDAJ EKİPMANLARI	33	SFT SONDAJ
12	SESA OTOMOTİV	34-35	SAYMAZ VİNÇ
13	ATAK SONDAJ MAKİNA	36	SÖZ CİVATA
14	GOLD DRİLL	37	TEKSAN HİDROLİK
15	OKURLAR MAKİNA	38	TKS MAKİNA
16	ERY TEKNİK RULMAN	39	YAŞAR MAKİNA
17	ALTINOLUK PLASTİK	40	ZEKA MAKİNA
18	ATLISAN MAKİNA		

SAHA[®]
YAYIN

ENERJİ & MADEN
DERGİSİ

Yayın İdare Merkezi

Bademlidere Mah. 253. Cad. No. 4/2
Çankaya/ANKARA
Tel: 0 312 433 58 01

Grafik-Tasarım

Alkım GÜNDOĞDU
Reklam Tanıtım Matbaa Hizmetleri
Tel: 555 516 25 86
alkimgundogdu@gmail.com

Reklam İletişim Adresleri

Tel: 0 535 939 92 05
www.sahayayin.com
enerjivemaden@gmail.com
instagram /enerjivemaden

Basım Yeri

Çağhan Ofset Matbaacılık San. ve Tic. Ltd. Şti.
İvedik Organize Sanayi Bölgesi 1341. Caddesi 1518. Sokak
Mat-Sit İş Merkezi F Girişi No: 2/15 Yenimahalle/ANKARA
Tel: 0312 397 71 83 - Faks: 0312 397 86 99

Bu katalogta yer alan çizimlerin
hakkı mahfuzdur.

İzin alınmadan, kaynak gösterilerek de
olsa iktibas edilemez.

Yayımlanan tüm ilanların sorumluluğu
ilan sahiplerine aittir.

aydinonat
friction products

**BRAKE, TRANSMISSION, CLUTCH DISCS AND PLATES FOR ALL
HEAVY DUTY, MINING AND TUNNEL MACHINES**



 www.aydinonat.com - info@aydinonat.com
 TEL: 312 394 5010 - FAX: 312 394 5014-15
 [instagram.com/aydinonatfrictionproducts/](https://www.instagram.com/aydinonatfrictionproducts/)
 [linkedin.com/company/aydinonat-frictionproducts/](https://www.linkedin.com/company/aydinonat-frictionproducts/)
IVEDIK OSB. 1435.CAD, NO:6 06370 OSTIM / ANKARA





BRONZ METAL SANAYİ

VE TİC. LTDİ ŞTİ.



SATIŞTA OLAN ÜRÜNLERİMİZ

BAKIR • PİRİNÇ • PASLANMAZ ALÜMİNYUM • FİBER • TEFLON
DELİRİN • CİVA ÇELİĞİ • POLİETİLEN • POLYAMİD
KESTAMİD • SFERO

☎ 0312 236 83 50 - 546 216 83 50 ✉ info@bronzmetalsanayi.com

📍 İvedik OSB Mah. 1479 Cadde No: 25 Yenimahalle / ANKARA

<https://www.bronzmetalsanayi.com>

HANSA FLEX

Hidrolik Sistem Partneri

“Maden sektörünün güvenilir çözüm ortağı HANSA-FLEX olarak üstün kaliteli ürünlerimiz ve mobil hidrolik servisimizle, 7/24 kesintisiz hizmet vererek, üretiminizi durdurmuyoruz”



Kod: KP 600 Kompakt Hortum

Akışkanlar & Kullanım Alanları: Mineral yağ, glikol, su (0 °C ila +70 °C), su-glikol emülsiyonları

Standart & Özel Nitelikler: ISO 18752-CC / Özellikle çok esnek, dar büküm radyüsü, aşınmaya, ozona ve iklim koşullarına karşı darbe testi ile test edilmiş 500,000 impuls

Kod: GE HR ED SSKV S Vidalı Bağlantı, Geçmeli Kaplin, Erkek

Bağlantı: BSP dış dış silindirik, kaplin bağlantısı

Ek Bilgiler: Malzeme ve yüzey koruması Çelik / Galvaniz kaplı, sızdırmalık şekli Forum E şeklindedir.



0216 394 31 00
0850 677 89 89



@hansaflextr



@hansa-flex tr



www.hansa-flex.com.tr



HASIRCI HİDROLİK



KOMATSU 380-6
SANZIMAN POMPASI
TRANSMISSION
PUMP



KOMATSU 420-3A
HİDROLİK POMPA
HYDRAULIC PUMP



KOMATSU 420-1
SANZIMAN POMPASI
TRANSMISSION
PUMP



KOMATSU 420-1
HİDROLİK POMPA
HYDRAULIC PUMP



KOMATSU 430-5
HİDROLİK POMPA
HYDRAULIC PUMP



KOMATSU 380-5
HİDROLİK POMPA
HYDRAULIC PUMP



İhdedik OSB Emineel Yapı Koop. 1474. Sk. (Eski 691. Sk.) No: 43 ANKARA/TÜRKİYE
+90312 395 53 07 +90312 395 53 17 info@hasircihidrolik.com

www.hasircihidrolik.com

+90 533 091 25 94



HİSİRCİ HİDROLİK



HİDROHAS

İş Makinaları Hidrolik ve Şanzıman Pompaları

*Hydraulics and Transmission Pumps
for the Heavy Construction Equipment*

Made in Türkiye



92 Z V-2
HİDROLİK
POMPA
HYDRAULIC PUMP

95 Z V-1 / 92 Z V-2
DİREKSİYON
POMPASI
STEERING PUMP

90 Z V -2
HİDROLİK POMPA
HYDRAULIC
PUMP

85 Z V -2
HİDROLİK POMPA
HYDRAULIC
PUMP

80 Z V -2
HİDROLİK POMPA
HYDRAULIC
PUMP



**KAWASAKI 80 Z III / 80-Z V
85-Z III / 85-Z IV / 85-Z V
90-Z III / 90-Z IV / 90-Z V-2 / 95 Z V-2
Hidrolik Pompa**



KAWASAKI 70
DİREKSİYON POMPASİ
STEERING PUMP



KAWASAKI 95 Z IV
DİREKSİYON POMPASİ
STEERING PUMP



KAWASAKI 95 Z IV / 92 Z V
ŞANZİMAN POMPASİ
TRANSMISSION PUMP



KAWASAKI
70 Z V
80 Z III/80 Z IV /80 Z V
85 Z / 85 Z III/85 Z IV / 85 Z V
90 Z III / 90 Z IV /90 Z V
ŞANZİMAN POMPASİ
TRANSMISSION PUMP



KAWASAKI
95 Z IV / 95 Z V
DİREKSİYON POMPASİ
STEERING PUMP



KAWASAKI 80 Z III
HİDROLİK POMPA
HYDRAULIC PUMP

*Marka ve modeller yalnızca bilgi amaçlıdır.
*Trademarks and models are for informational purposes only.

ATCOVI



EGE ATLAS İŞ MAKİNALARI VE YEDEK PARÇA YERALTI MADEN MAKİNALARI YEDEK PARÇA



**Salon 8
Stant 836A**



22 yılın tecrübesi ve sorumluluğu ile her zaman daha iyiyi hedefleyerek, kendimizden emin bir şekilde yolumuza devam ediyoruz.
www.egeatlas.com.tr | export@egeatlas.com.tr

+90 312 385 12 53



Saraykent Caddesi No: 7A
Kahramankazan / ANKARA



TÜRKİYE'NİN EN BÜYÜK SONDAJ EKİPMANLARI ÜRETİCİSİ VE YEDEK STOĞU

rpmsondaj.com



Salon: 3 Stant: 305





İş Makineleri Yedek Parça Çözümlerinde Güvenilir İş Ortağınız



IVEDİK OSB MAHALLESİ 1518. CADDE NO:16 YENİMAHALLE 06378 ANKARA/ TURKEY
Telefon: +90 312 395 22 88
Cep Telefonu: +90 539 857 56 46
Mail: sesa@sesaotomotiv.com
Website: www.sesaotomotiv.com





ATAK

ATAK SONDAJ MAKİNA SAN. VE TİC. LTD. ŞTİ.



Atak Makina 18 Şubat 2021 tarihinde sondaj makinası üretimi ve servis sağlayıcı firma olarak faaliyete geçmiştir. Kurulduğu günden bugüne kadar Atak Makina, yerli üretim bandı ile sondaj makinası üretiminde kısa sürede sektörün öncü firmaları arasında kaliteden ödün vermeyerek ismini üst sıralara taşımayı başarmıştır.

Atak 2000 Yüzey Sondaj Makinası

Estetik yapısı ile dikkat çekici görünürken; hava şartları ve zemin koşulları ne kadar zorlu olursa olsun sağlamlığı, pratik kullanımı, gücü ve İSG kurallarına uygun üretimi ile maden sondajı sektöründe kalitesini kanıtlamış ve adından övgü ile söz ettirmeyi başarmıştır.



[/ataksondajmakina](https://www.facebook.com/ataksondajmakina)

[/ataksondajmakina](https://www.instagram.com/ataksondajmakina)

[/ataksondajmakina](https://www.youtube.com/ataksondajmakina)

[/ataksondajmakina](https://www.linkedin.com/company/ataksondajmakina)

[/ataksondajmakina](https://www.instagram.com/ataksondajmakina)

[/ataksondajmakina](https://www.linkedin.com/company/ataksondajmakina)

info@ataksondajmakina.com.tr

info@ataksondajmakina.com

info@adatakmakina.com

info@atakmakine.com.tr

[İvedik OSB Mah. 1448. Cad. No: 31
Yenimahalle/ANKARA](https://www.google.com/maps/place/İvedik+OSB+Mah.1448,+Cad.No:31+Yenimahalle/ANKARA)

[+90 312 354 32 48](tel:+903123543248)

[+90 532 550 42 77](tel:+905325504277)

www.ataksondajmakina.com.tr



"KALİTEYİ İMAL EDİYORUZ"
SONDAJ MAKİNA VE EKİPMANLARI



İVEDİKKÖY MAH. MELİN GÖKÇEK BLV. NO:140/B YENİ MAHALLE / ANKARA-TÜRKİYE

TEL : +90 312 394 11 81

FAX : +90 312 394 11 82

WHATSAPP : +90 532 499 80 79

MAIL : SALES@GOLDDRILL.COM.TR

WWW.GOLDDRILL.COM.TR

YARIM ASIRLIK TECRÜBE KESİNTİSİZ GÜÇ

1975 yılında temelleri atılan **Okurlar Makina Motor**, yarım asrı geçen köklü tecrübesiyle dizel motor tedarikinde yüksek kalite ve sarsılmaz güvenin öncülüğünü yapıyor. İlk günden bugüne taviz vermediğimiz kalite anlayışımız ve yenilikçi vizyonumuzla, en zorlu projelerinizde çözüm ortağınız olmaya devam ediyoruz.

✓ **Dizel Motorlar**

✓ **Motor Yedek Parçaları**

✓ **YUNNEI POWER Türkiye Distribütörü**

✓ **OMMO Spare Parts**

İLETİŞİM:

- +90 532 488 64 79 / 444 3 852
- www.okurlarmakina.com.tr
- info@okurlarmakina.com.tr
- ANKARA / TÜRKİYE

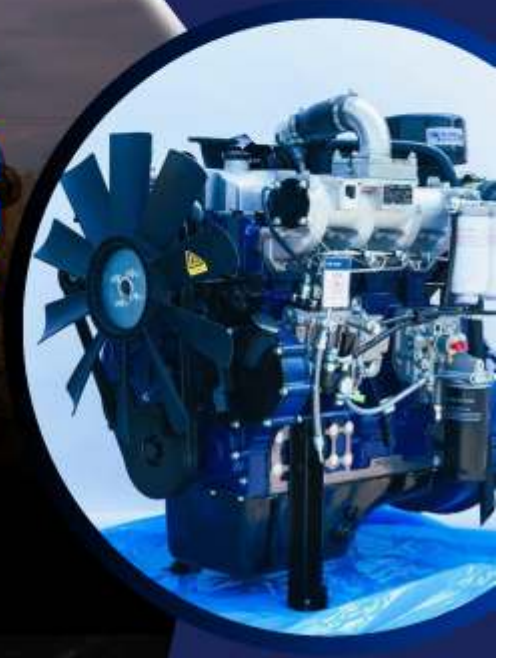

ERY

ERY TEKNİK RULMAN OTOMOTİV SAN. VE TİC. LTD. ŞTİ.



**TÜM İŞ
MAKİNALARI
RULMAN, KAYIŞ, KEÇE,
TANDEM ZİNCİRİ VE
YEDEK
PARÇALARI**

İ Ostim Osb Mah. Uzayçağı Cad. 1433 Sokak
No: 6/A (Ata İş Merkezi) Yenimahalle/ANKARA

☎ 0541 601 28 83

✉ eryteknikrulman@gmail.com



CAT
JCB
VOLVO
CASE
CONSTRUCTION
KAWASAKI
HİDROMEK
KOMATSU
HYUNDAI



ALTINOLUK

PLASTİK

'Kaliteyi Saklıyoruz'



Empty stacked, and heated

Stacked, with core. Lids maximize stability.

Without lids, just inside trays. They do not touch core below.



Altinoluk Plastik

Enjeksiyon Sondaj Tarım Sulama San. Tic. Ltd.Şti.

📍 2.05B Kırım Caddesi Sarıçiçek Sokak No:2 Selçuklu, KONYA-TURKEY

☎ 0 332 502 02 40 📞 +90 (532) 431 01 06 📞 +90 (533) 157 58 90

✉ info@altinolukplastik.com www.altinolukplastik.com

'NERELERDE KULLANILIR'

- Jeoteknik sondaj firmaları
- Maden sahaları
- İnşaat projeleri
- Arkeolojik kazılar

ATLISAN



• Ostim OSB 1187. Cadde No:18 Yenimahalle/ANKARA • +90 532 247 19 68 • +90 532 247 19 68 • www.atlisan.com • info@atlisan.com

AZE

HİDROLİK & PNÖMATİK

⚙️ Hidrolik Proje Pnömatik Sistem Montajı Revizyonu

⚙️ Yüksek Basınçlı Hidrolik Hortum Yapımı Montajı

⚙️ Pompa ve Silindir Montajları

⚙️ Hidrolik Pnömatik Ürün Temini



☎️ 0312 394 55 50

📍 Ostim OSB, Ahi Evran Cd. No:87 Yenimahalle / Ankara

🌐 www.azehidrolik.com

✉️ info@azehidrolik.com



LÜTFEN BURAYA BAKMAYINIZ.



bn beton
market



www.betonmarket.net

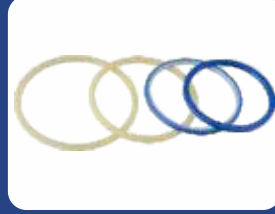

YENİ ERKA İŞ MAKİNALARI SIZDIRMAZLIK EKİPMANLARI İTH. İHR. SAN. VE TİC. LTD. ŞTİ.

Ostim OSB Mah. Ahi Evran Cd. No: 18/8 Yenimahalle/ANKARA

Gsm: +90.535 419 85 18 • E-posta: info@er-kagrup.com

www.er-kagrup.com

Mobil ve Endüstriyel hidrolik
Sektöründe
Hidrolik Pompa ve Motor

*Komple ekipman temini

*Tamir ve bakımı

*Yedek parça temini

PARKER

REXROTH

A BOSCH COMPANY

KPM

Kawasaki Precision
Machinery

**SAUER
DANFOSS**

İLETİŞİM

Ramazan ER
0532 452 25 07
tel:0312 394 19 84
fax:0312 394 19 83
info@flowhidrolik.com
ramazanerr@hotmail.com

İvedik OSB Mah.
Havalandırmacılar Cad. No:51
Yenimahalle/Ankara



**SONDAJ DA ÖNCÜ
ADIMLAR.HİDROLİKLE
BAŞLAR.**

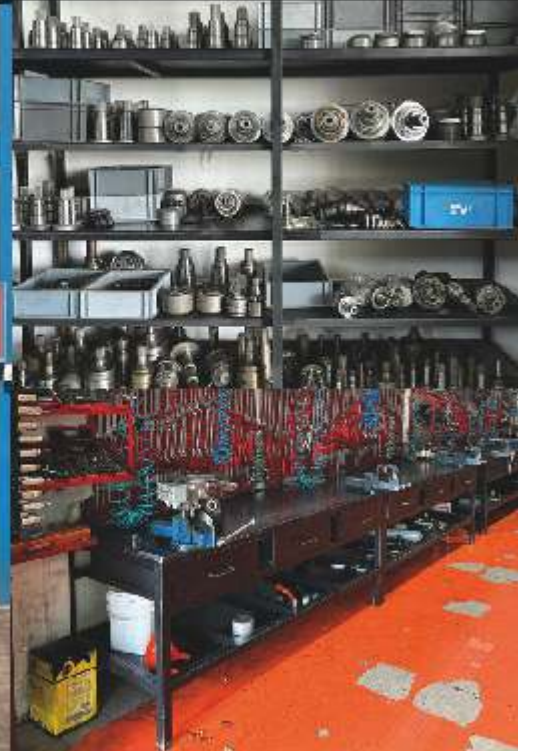

GENMAK®

GENEL İŞMAKİNALARI VE YEDEK PARÇA
SANAYİ TİCARET LİMİTED ŞİRKETİ

FİLTRELER • TIRNAKLAR • YEDEK PARÇA



KAWASAKI, HITACHI, MITSUBISHI, VOLVO, WABCO, CLARK, TEREX, ALLİSON, DETROİT DİZEL, GENERAL MOTOR, BOMAG, HAMM, WÖGELE, WİRTGENİ iş makinelerinin yedek parçaları ve stoklarımızda, KOMATSU, VOLVO, CATERPİLLAR, CUMMINS, YANMAR, PERKINS, DEUTZ, İVECO vb. motor parçalarını da orijinal veya muadili olarak temin etmekteyiz.



Abdulkadir Geylani Cad. No: 1/8
06370 Ostim/ANKARA
Tel +90 312 385 25 69 (pbx)
Faks : +90 312 385 43 86

GENMAK®

www.genmakismakinalari.com

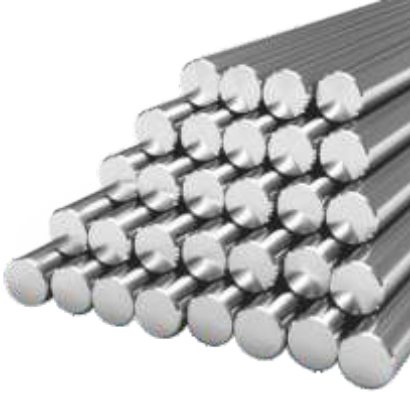
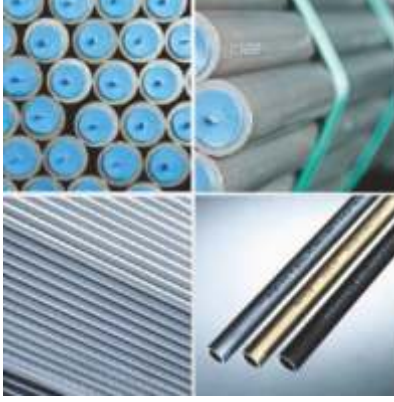

📍 OSTİM OSB 1246 Cadde No:35 Yenimahalle / ANKARA

☎ +90 312 395 10 78-79

☎ +90 536 863 42 27





HAKİM HİDROLİK

BORU - MİL



- Sert Krom Kaplı Miller
- İndüksiyonlu Krom Kaplı Miller
- Kromlu Rot Borular
- H8 Honlanmış Borular
- H9 Kullanıma Hazır Borular
- Hidrolik Devre Boruları
- Hidrolik Silindir Yedek Parçaları

www.hakimhidrolik.com.tr

info@hakimhidrolik.com.tr



Hidrolik Pompa ve Hidromotor Teknolojisi

İleri Mühendislik, Güçlü Üretim

Tecrübe, teknoloji ve üretim disiplini' bir araya getirerek sanayiye güvenilir hidrolik çözümler sunuyoruz.

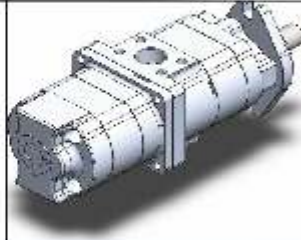
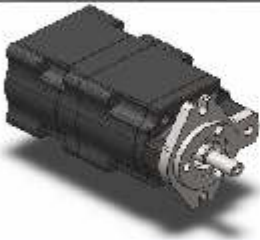
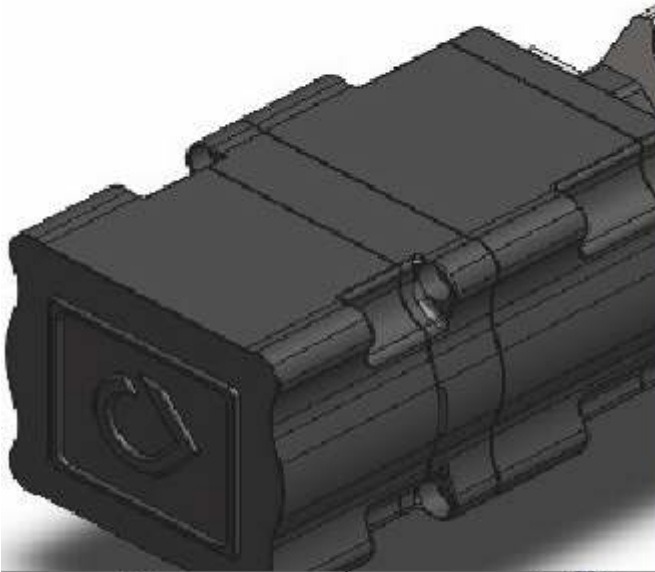

Daima ilerde ol.

HM HİDROMİL

HİDROLİK

HONLANMIŞ BORU-KROMLU MİL

- ◆ HONLANMIŞ BORU H8
- ◆ HONLANMAYA HAZIR BORU H9
- ◆ KROMLU MİL
- ◆ İNDÜKSİYONLU KROMLU MİL
- ◆ KROM KAPLI ROT BORU
- ◆ HİDROLİK TESİSAT BORUSU
- ◆ KEP PİSTON VE ARKA KAPAKLAR
- ◆ HİDROLİK BAĞLANTI ROT MAFSALLARI



☎ **0312 543 69 79** ☎ **0546 843 69 79**

📍 Ostim OSB 1232.Cd. No:93 Yenimahalle/ ANKARA

✉ info@hidromil.com ✉ satis@hidromil.com

🌐 www.hidromil.com

www.sahayayin.com

ISIM İŞ VE İNŞAAT
MAKİNELERİ
KÜMELENMESİ ÜYESİDİR

MADEN TÜRKİYE 2026

27



HİDRO
PNÖMATİK

HİDRO
HİDROLİK - PNÖMATİK



SİSTEM
HORTUM - REKOR

HİDRO-SİSTEM HİDROLİK PNÖMATİK SAN. ve TİC. LTD. ŞTİ.

📍 M: İvedik Osb Mah.1419. Cad. No:18 Yenimahalle / ANKARA
Ş: İvedik Osb Mah.1419. Cad. No:19 Yenimahalle / ANKARA

☎ +90 312 394 41 96 - 97 • +90 545 394 41 96

✉ hidro-sistem@hidro-sistem.com 🌐 www.hidro-sistem.com



Hidrotek Teknik®

Hortum • Rakor • Boru

HİDROLİK HORTU & PRESLEME



Hidrolik hortumlar
olan ve hortum &
presleme cihazları



Hidrolik hortumlar
krandiyeye onarı
preslemezen
hidroman
hidroman &
presleme ünitesi



Her logic manifold
türü için alan bir
logic manifold

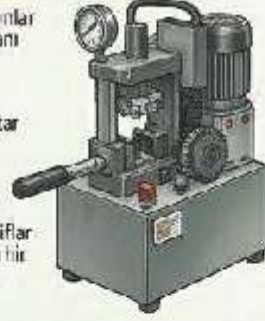

Hidrolik Hose
Skiving Machine



PNÖMATİK ÜRÜNLER

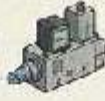

Air Logic Manifalderin hortumları
air logic'ten pnömatik ölçüleri



SU FITTINGLERİ



KIRICI VE DELİCİ TESİSATLARI

Hidrolik hortumluk kit ve
pneumatik drili attatmii ve
pneumatik belimli
kontlem kitler



Konere
Spraying
Hosunlar



ADRESİMİZ: OSTİM SANAYİ SİTESİ
100. YIL BULVARI NO: 13, ANKARA



CEP İLETİŞİM:
0532 355 0799



WEB SİTESİ:
hidrotektechnik.com.tr

MANAS

SONDAJ EKİPMANLARI
DRILLING EQUIPMENT



Kalite Performans Manas.



Madencilik ve jeoloji projeleriniz için güvenilir çözüm ortağınız

Madencilik ve zemin etüdü projeleri, değişik alanlar. Biz de böyle. Manas Sondaj olarak, dünyanın en zorlu sahalarında çalışan ekiplerin ihtiyaç duyduğu ekipman desteğini, sundukları asan bir hizmetle sağlıyoruz. Amacımız sadece işin satmak değil, projenizin kesintisiz devam etmesini sağlayan güvenilir öneriler sunmaktır.

Özellikle zemin zemin koşulları için geliştirdiğimiz Newton Serisi karot uçları ve bitiş işlemlerimiz, işlerde fark yaratıyor. Yüksek kesme hızı, uzun ömür ve maksimum sacel verimi sunan ürünlerimizle, projenizin maliyetlerini düşüyoruz. Standartlara uygun üretimimiz ve kalite kontrol süreçlerimizle, her zaman en iyisini hedefliyoruz.

İstediğiniz işlemin yüksek mukavemetli ürünleriniz ve özel malzeme yapısına sahip olması, en agresif zeminlerde bile uzun ömür sunar. Sektörün değişen dinamiklerini yakından takip ediyor, teknolojiyi sahaya entegre ediyoruz. Çünkü biliyoruz ki, iyi bir sondaj, güçlü bir ekipmanla yapılır.

www.manasltd.com.tr

Tel: +90 544 738 31 85

info@manasltd.com.tr

ROCK DRILLING SPARE PARTS

MANUFACTURER

THE DRILLING POWER OF THE WORLD !

www.orglobal.com.tr

RELIABILITY | PERFORMANCE | QUALITY | COMPETITIVE PRICES



WORLDWIDE FAST SHIPPING

- Drifter Spare Parts and Complete Drifter
- Jumbo , Rock Spare Parts
- Hydraulic Cylinder , Valve , Pump
- Drifter,Cylinder,Valve,Pump Seal Kit
- Dust and Other Rubber's , Diaphragm's
- Filler's



+90 545 313 06 13

www.orglobal.com.tr

[orglobalmachine](https://www.instagram.com/orglobalmachine)

OTOMOTIV SAVUNMA SANAYİ İNŞAAT İŞ MAKİNELERİ MADENCİLİK DENİZCİLİK VE HAVACILIK
MEDİKAL DONANIMLI CİHAZLAR DEMİR ÇELİK VE HADDEHANELER RAYLI SİSTEMLER TARIM



- Yüksek Basıncılı Hidrolik Rekorlar •Paslanmaz Bağlantı Elemanları •Pirinç Bağlantı Elemanları
- Hidrolik ve Pnömatik Bağlantı Elemanları •Hidrolik ve Pnömatik Hortumlar •Hidrolik ve Pnömatik Nipeller
- Hidrolik Hortum Sıkma Presi •Hidrolik Hortum Kesme ve Soyma Makinesi •Hidrolik ve Pnömatik Vanalar



İvedik O.S.B 1471. Cadde No:2
Yenimahalle/Ankara

+90 (312) 395 2578
0850 420 19 90

bilgi@ozteknikrekor.com.tr
www.ozteknikrekor.com

0545 449 99 89

SFT
SONDAJ

SFT
SONDAJ

**YER ALTININ
YERLİ KAHRAMANI**



MADEN

Salon: 4 Stant: 422A



www.sftsondaj.com

Saymaz CNC Vinç San. ve Tic. A.Ş. 2020 yılında kurulmuş olup, gezer köprülü vinç ve kaldırma ekipmanları üzerine proje, imalat, montaj ve satış sonrası hizmetler faaliyetlerini yürütmektedir. Uzman personeli, kaliteli ürünleri ve koşulsuz müşteri memnuniyeti ilkesi ile Saymaz Vinç, kısa sürede sektörünün önemli firmaları arasına girmeyi hedeflemektedir. 3000 m² kapalı alana sahip modern üretim tesisimiz, talaşlı imalat, kaldırma ve yürütme grupları montaj istasyonları ve çelik konstrüksiyon-kaynak imalathanelerinden oluşmaktadır. Saymaz Vinç, devam eden yatırımları ve AR-GE çalışmaları ile güvenli ve teknolojik ürünler üretmektedir. Bu sayede ülkemiz sanayisine değer katmaktadır. Bunu, eklediği teknolojik yenilikler ve ileri mühendislik çalışmaları sayesinde sağlamıştır.

Arabalı Vinç

Monoray Vinç

Tek & Çift Kiriş Gezer Köprülü Vinçler

Portal Vinç

MAKSİMUM GÜÇ

Saymaz Vinç tarafından üretilen vinçler FEM standartları ve DIN normlarına uygundur.



www.saymazvinc.com.tr

SAYMAZ CRANE SYSTEMS



Başkent OSB Başkent Bulvarı No: 90 Malıköy, Sincan-ANKARA
Tel: 0 312 557 60 61 • E-posta: info@saymazvinc.com.tr

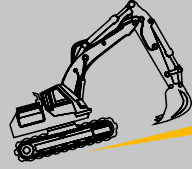

SÖZ

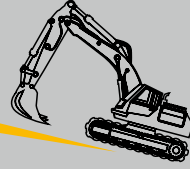

CİVATA İŞ MAKİNALARI

Özel Üretim Civatalar

Bıçak Civataları | Palet Civataları | Şase Civataları | İNÇ İMBUS
İNC AKB Flanşlı Civatalar | Özel İmalat Civatalar | 10,9-12,9 KALİTE



Ostim OSB Mah. 1234 Cad. No: 114 Yenimahalle / ANKARA
email: yunusgulasti@gmail.com • tuncaysozcivata@hotmail.com
Tel: 0.507 440 91 30 - 0.507 857 24 94

SEKTÖRDE

KALİTE VE GÜVENİN ADRESİ



ÜRÜNLERİMİZ

- ▶ Hidrolik Hortum Rakorları
- ▶ Hidrolik Bağlantı Elemanları
- ▶ Hidrolik Hortum Çeşitleri
- ▶ Hidrolik Hortum Rakoru Sıkma Presleri
- ▶ Hidrolik Hortum Kesme Ve Soyma Makinası
- ▶ Hidrolik Ve Pnömatik Malzemeler
- ▶ Hidrolik Borular ve Şekillendirme



DİSTRİBÜTÖRLÜKLERİMİZ

SEMPERIT 
Hidrolik Hortumları

DİESE
Hidrolik Hortumları



www.teksanhidrolik.com.tr
teksan@teksanhidrolik.com.tr



MERKEZ / SATIŞ

Ostim Org. San. Bölgesi 100. Yıl Bulvarı
No: 114 06370 Ostim / ANKARA / TÜRKİYE
Tel : +90 312 354 43 23 - 354 50 03
Fax : +90 312 354 29 50

FABRİKA

ASO 1. Org. San. Bölge, Kırım Hanlığı Cad.
No: 15 06935 Sincan / ANKARA / TÜRKİYE
Tel : +90 312 395 85 16 (pbx)
Fax : +90 312 395 85 19

M[®] YAŞAR MAKİNA

*Jeneratör ve Motopomp
Tarım ve Güç Ürünleri
Marin Ürünleri ve Güvenilir Markalar*

Pompa	Pompa Tipi	Devir	HP	Motor	Emiş Çıkış	DEBİ	HM
Salyangoz	SD 215	3.000	20	YM 292-PRC	2- 11/2	20-29 m ³ /h	95-65 mSS
Salyangoz	SD 325	3.000	20	YM 292-PRC	3- 21/2	40-75m ³ /h	60-43 mSS
Salyangoz	SD 430B	3.000	25	9 LD 625-2-KOHLER	4- 3	45-140 m ³ /h	48-15mSS
Salyangoz	SLG 540	3.000	35	KDW 1404-KOHLER	5-4	90-160 m ³ /h	48-31mSS
Salyangoz	SD430	3.000	40	KDI1903-KOHLER	4-3	90-140 m ³ /h	69-51 mSS
Salyangoz	ECO SNT 50-200	3.000	20	YM 292-PRC	21/2 . 2	50m ³ /h	55 mSS
Salyangoz	ECO SNT 65-200	3.000	25	9 LD 625-2-KOHLER	3-2	100m ³ /h	50 mSS
Salyangoz	ECO SNT 80-200	3.000	35	KDW 1404-KOHLER	4-3	150m ³ /h	45 mSS
Salyangoz	SLG 860	1.500	50	41041-YAVUZ	8-8	550m ³ /h	12 mSS
Salyangoz	SCE350-350	1.500	330	9E33 FORD ECOTORQ	16-14	1.800 m ³ /h	30 mSS
OTO. EMİŞLİ	TKF-KE/UKM-S	1.500	35	31041-YAVUZ	4-4	60-160m ³ /h	26-20 mSS
OTO. EMİŞLİ	TKF-KE/UKM-S	1.500	50	41041-YAVUZ	6-6	80-300 m ³ /h	33-20 mSS
OTO. EMİŞLİ	TKF-KE-UKM-S	1.500	75	42041-YAVUZ	8-8	150-600 m ³ /h	34-20 mSS
OTO. EMİŞLİ	TKF-KE-UKM-S	1.500	100	43041-YAVUZ	10-10	250-825 m ³ /h	40-25 mSS

YAŞAR MAKİNA

Merkez : 100.Yıl Bulvarı No: 52 Ostim-ANKARA **Tel: 0.312.354 83 36**

Şube : 1173. Sokak No: 3 Ostim-ANKARA **Tel: 0.312.385 80 71**

Servis : 1173. Sokak No: 7 Ostim-ANKARA **Tel: 0.312.385 74 12**

e-posta : info@yasarmak.com.tr ergundoner@yasarmak.com.tr

web : www.yasarmak.com.tr www.yasargenerator.com





ZEKA MAKİNA

ÇELİK ÖRGÜ, TIKANMAZ, KROM NİKEL ve POLİÜRETAN ELEKLER

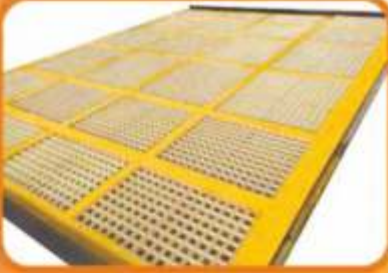

“1983'den günümüze sektöre öncülük etmekten gurur duyuyoruz...”



ZEKA MAKİNA ELEKTRİK İNŞAAT TİCARET LİMİTED ŞİRKETİ

ZEKA MACHINERY ELECTRICITY CONSTRUCTION TRADE LIMITED COMPANY

Ostim 05B1183. Sokak (Eski 13. Sokak) No: 52 - 54 - 56 - 58

Ostim 06370 Ankara / Türkiye

Tel: +90 312 354 32 61 • +90 312 354 32 63

+90 312 354 35 05 • +90 312 385 10 51

Faks: +90 312 354 35 06

info@zekamakina.com.tr | www.zekamakina.com.tr





T.C. ÇALIŞMA VE
SOSYAL GÜVENLİK BAKANLIĞI



İSTANBUL
SANAYİ ODASI

TOSH EXPO

6. TÜRK İŞ GÜVENLİĞİ VE
SAĞLIĞI FUARI

www.toshexpo.com.tr

Eş Zamanlı Etkinlik
T.C. Çalışma ve Sosyal Güvenlik Bakanlığı
İstanbul Sanayi Odası
10. Uluslararası İş Sağlığı ve Güvenliği Konferansı

Görüşmek üzere!

**6 - 8 MAYIS
2026**

BU FUAR 5174 SAYILI KANUN GEREĞİNCE
TOBB (TÜRKİYE ODALAR VE BORSALAR BİRLİĞİ)
DENETİMİNDE DÜZENLENMEKTEDİR.

A Member of the
A+A
Event Portfolio

 **tezulas**
Tezulas Fuar Dan. Hizm. Ltd. Sti.

ICC İSTANBUL
CONGRESS
CENTER

Messe
Düsseldorf



HAKİM HİDROLİK BORU - MİL

- Sert Krom Kaplı Miller
- İndüksiyonlu Krom Kaplı Miller
- Kromlu Rot Borular
- H8 Honlanmış Borular
- H9 Kullanıma Hazır Borular
- Hidrolik Devre Boruları
- Hidrolik Silindir Yedek Parçaları



📍 OSTİM OSB 1246 Cd. No:35
Yenimahalle / ANKARA

☎ +90 536 863 42 27

✉ info@hakimhidrolik.com.tr

☎ +90 312 395 10 78-79

🌐 www.hakimhidrolik.com.tr

